

# **CABANA RUN**

## **ASSEMBLY GUIDE**



## Welcome!

Congratulations on becoming an owner of a premium Somerzby product! We hope it brings you and your pet/s many years of enjoyment and contentment.

When your flat pack arrives, please check all items for any damage that might have occurred in transit.



02 4340 4200

[info@somerby.com.au](mailto:info@somerby.com.au)

## What you will need

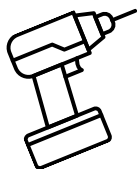

You'll need a battery-powered screwdriver or drill with a Phillips head bit, as well as a flat, level surface to ensure proper alignment of all doors during assembly.







## Important Things To Note



- The instructions and screws can be found in carton #1.
- A strong smell may be present when opening. This is the natural timber scent and is not harmful to humans or animals. It will fade over time, especially when placed outdoors.
- When joining two panels, the 1st panel has a guide hole to show where the screw goes. The 2nd panel does not have a predrilled hole. The screw goes directly into the solid timber and forms a tighter join.
- You may notice a shiny or powdery residue on the panels; this is crystallised sap from the natural wood-drying process. It's completely safe for pets and people and can be wiped off or left as is.

# Check list

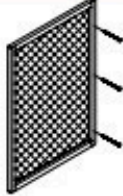
## ASSEMBLY INSTRUCTION

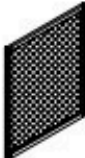
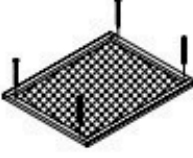
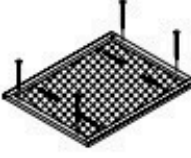
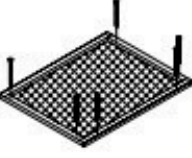
P1	 3.5 × 60	22pcs+1 spare					
P2	 3.5 × 45	20pcs+1 spare	Ⓐ1 X1	Ⓐ2 X1	Ⓑ X1	Ⓒ X2	Ⓓ X1
							
			Ⓔ X1	Ⓕ X1	Ⓖ X1	Ⓗ X1	

## How to Assemble the Cabana Run Step 1

### PARTS

#### Parts required for step 1

A1, B, C

#### Screws:

P1 x 6

#### Assemble The First Side:

**Attach panel A1 to B:** Locate the pre-drilled holes on the inside edge of panel B. Align panel A1 to B, then screw P1 x 3 through the guide holes to secure B to A1, ensuring all stapled wire sides are facing away.

**Attach panel B to C:** Locate the pre-drilled holes on the inside edge of panel B, then align B with C. Use P1 x 3 to screw through the guide holes ensuring all stapled wire sides are facing away.

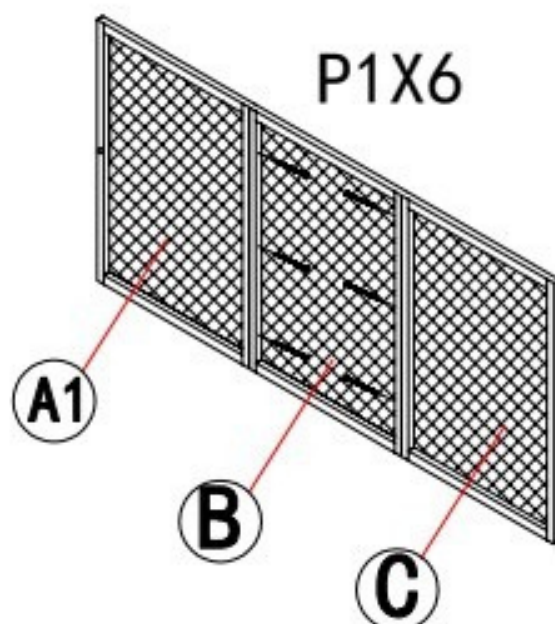

STEP1

## How to Assemble the Cabana Run Step 2

### PARTS

#### Parts required for step 2

A2, C, D, E

#### Screws:

P1 x 6, P2 x 6

### Completing The Sides

**Attach Panel A2 To D:** Locate the pre-drilled holes on the inside edge of door panel D. Align Panel A2 with D, making sure the stapled wire sides are facing away.

Secure the panels together using P1 x 3 screws through the guide holes of D.

**Attach Panel C To D:** Locate the pre-drilled holes on the other inside edge of panel D. Line up panels C and D, then screw P1 x 3 through the guide holes ensuring all stapled wire sides are facing away.

**Attach End Panel E:** Locate the pre-drilled holes along the end edge of Panel C. Align Panel E with Panel C as shown in the diagram, making sure the stapled wire sides are facing inward.

Secure panels together by screwing P2 x 3 through the guide holes.

Repeat on the opposite side with the Second Panel C, again ensuring the stapled wire sides face inward.

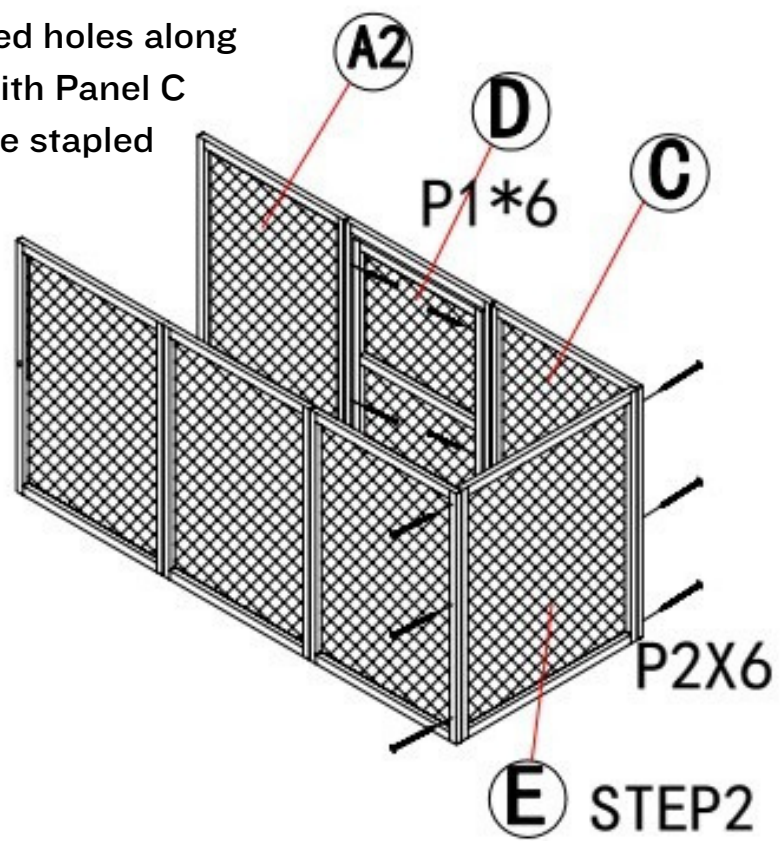

## How to Assemble the Cabana Run Step 3

### PARTS

#### Parts required for step 3

F, G, H

#### Screws:

P1 x 4, P2 x 14

### Attaching The Roof Panels

Position Panels F, G, and H on top of the side panels as shown in the diagram, with all stapled wire sides facing downward. Align the panels carefully, noting the pre-drilled screw hole locations.

Attach Panel G to Panels F and H through the pre-drilled holes on the inside edges of G using screws P1 x 4.

Next, secure the entire top section (F, G, and H) to the side panels using screws P2 x 14.

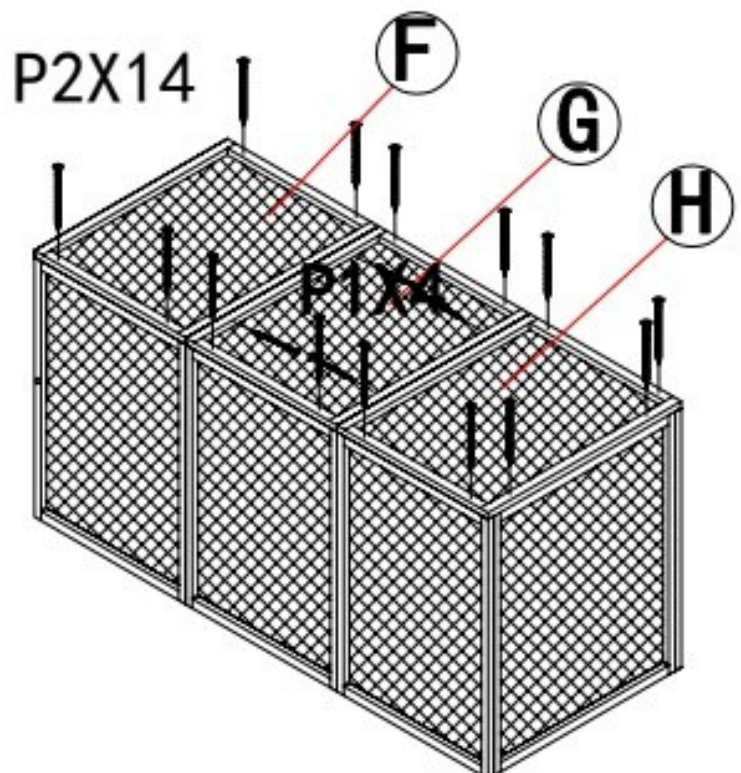

## How to Assemble the Cabana Run Step : FINISH

### PARTS

PScrews required for step FINISH

P1 x 6

**Note: Complete this step only if you are attaching the run to the Cabana House. If using the run on its own, assembly is now complete.**

### Attach The Run To The House

Position the run flush against the edge of the house, as shown in the diagram.

Using the pre-drilled holes, secure the run to the house with P1 x 6.

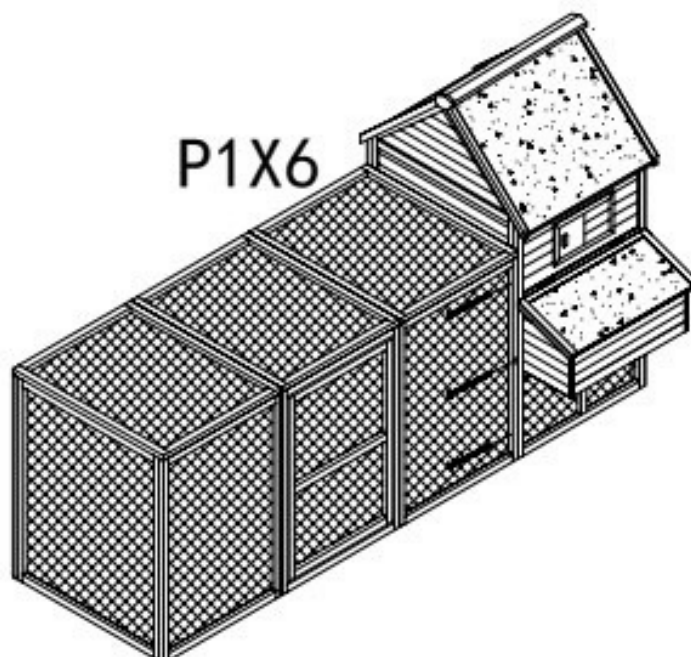

FINISH



## FAQ

Frequently asked questions

### Contact Information

Phone: 02 4340 4200

Email: [info@somerzby.com.au](mailto:info@somerzby.com.au)

### Customer Service Office Hours

Monday – Thursday: 9:00am – 4:30pm

Friday: 9:00am – 4:00pm

Saturday & Sunday: Closed

Public holidays: Closed

[www.somerzby.com.au](http://www.somerzby.com.au)

**#somerzby**

