

CHALET

ASSEMBLY GUIDE



Welcome!

Congratulations on becoming an owner of a premium Somerzby product! We hope it brings you and your pet/s many years of enjoyment and contentment.

When your flat pack arrives, please check all items for any damage that might have occurred in transit.



02 4340 4200

info@somerby.com.au

What you will need

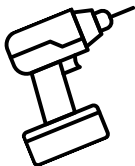



You'll need a battery-powered screwdriver or drill with a Phillips head bit, as well as a flat, level surface to ensure proper alignment of all doors during assembly.

Important Things To Note

- The instructions and screws can be found in carton #1.
- A strong smell may be present when opening. This is the natural timber scent and is not harmful to humans or animals. It will fade over time, especially when placed outdoors.
- When joining two panels, the 1st panel has a guide hole to show where the screw goes. The 2nd panel does not have a predrilled hole. The screw goes directly into the solid timber and forms a tighter join.
- You may notice a shiny or powdery residue on the panels; this is crystallised sap from the natural wood-drying process. It's completely safe for pets and people and can be wiped off or left as is.

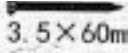
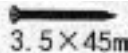
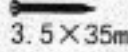
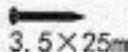
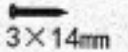
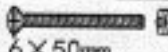

Check list

P1	 3.5×60mm	6pcs+1spare	P2	 3.5×45mm	14pcs+1spare
P3	 3.5×35mm	12pcs+1spare	P4	 3.5×25mm	4pcs+1spare
P5	 3×14mm	14pcs+1spare	P6	 6×50mm	8pcs
P7	 350mm	1pc			



(A) *1



(B) *1



(C) *1

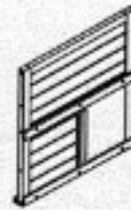

(D) *1

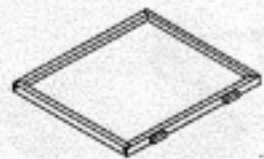

(E) *1

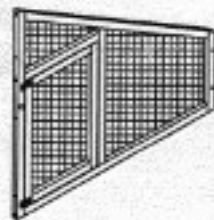

(F) *1

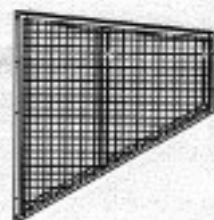

(G) *1



(H) *1



(I) *1



(J) *1



(K1) *1



(K2) *1



(L) *1

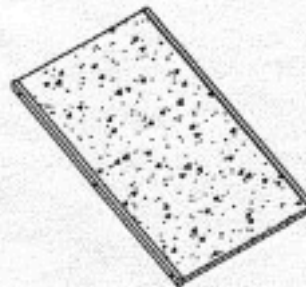

(M) *1

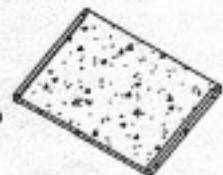

(N) *2

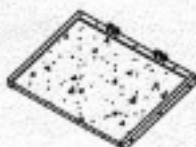

(O) *1



(P) *1



(Q) *1



(R) *1



(S) *1

How to Assemble the Chalet Step I

PARTS

Parts required for step 1

A, B, C, D

Screws:

P2 x 10

Assemble The Housing Area:

Attach Panel A to C: Align panel A to C, ensuring the stapled side of the wire is on the inside. Locate the pre-drilled holes on panel A. Use screws P2 x 3 to attach,

Attach Panel C to B:

Align panel B to C, ensuring the stapled wire side is on the inside. Locate the pre-drilled holes on B and use screws P2 x 3 to attach.

Attach Panel D to A and B: Using the guide dowels, align panel D between A and B as shown. Locate the pre-drilled holes on panels A and B. Use screws P2 x 4 to attach.

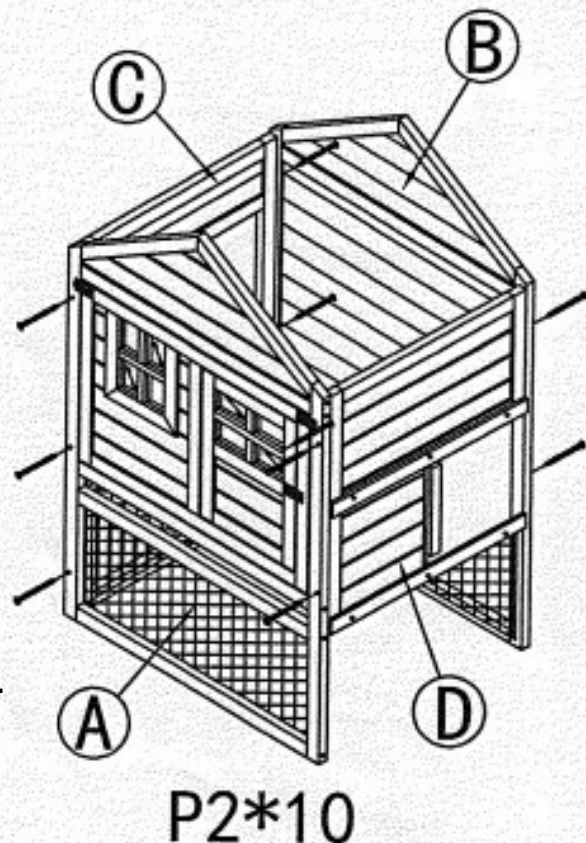

STEP 1

How to Assemble the Chalet Step 2

PARTS

Parts required for step 2

P, Q, P7

Screws;

P5 x 8

Attach The Ramp To The House: Use screws P5 x 4 to attach the hinges of the ramp below the small entry door to the house.

Attach The Handle Component To The Door: Use screws P5 x 4 to attach the small metal rod and guide bracket halfway up the front edge of the sliding door as shown.

Position Roosting Pole: Place 1 x Q into 'U' shaped holder inside the house.

Note: If not using for chickens, part Q can be left out.

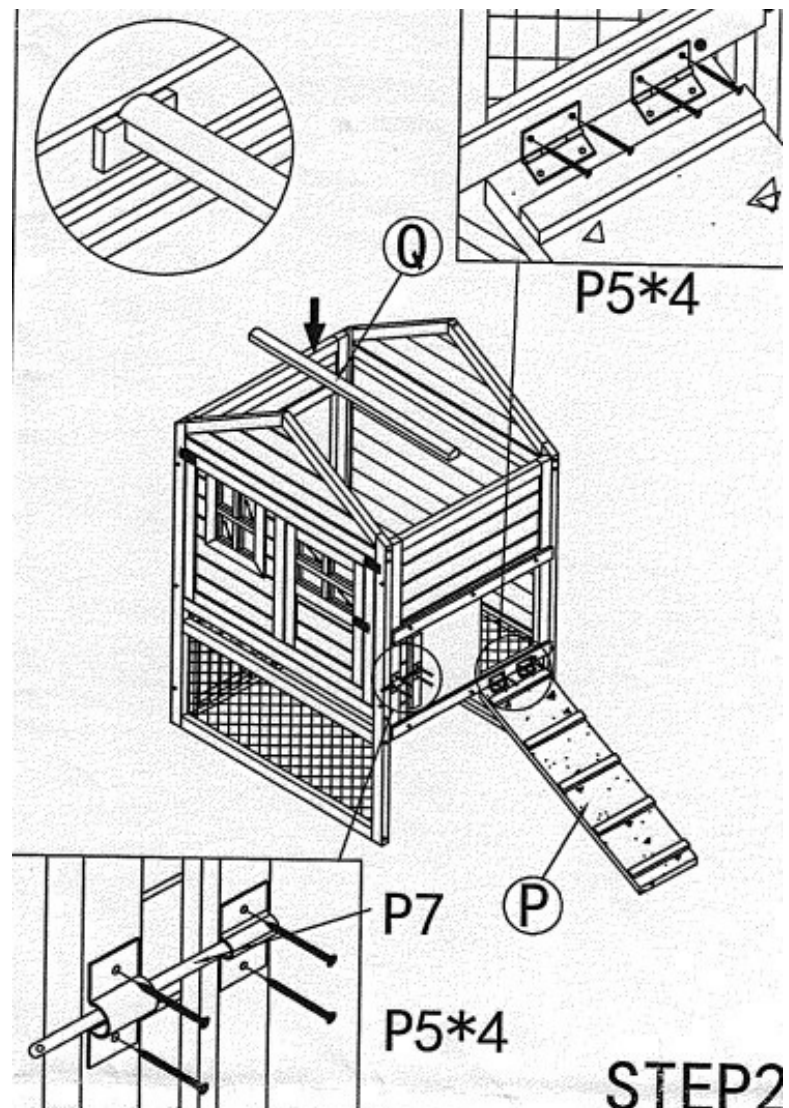

How to Assemble the Chalet Step 3

PARTS

Parts required for step 3

F, G, H, P7

Screws

P2 x 4, P1 x 6

Attach The Run: Align panel F with the front side of house as shown, ensuring the metal rod is aligned with the hole cut out. Locate the pre-drilled holes on part F and use screws P1 x 6 to attach.

Align panel G to the back side of the house. Use screws P1 x 6 to attach.

Next, align part H between F and G. Locate the pre-drilled holes on F and G and use screws P2 x 4 to attach.

Finish The Sliding Handle: Join the two handle pieces together from the outside using the P7 nut and bolt- a shifting spanner may be required.

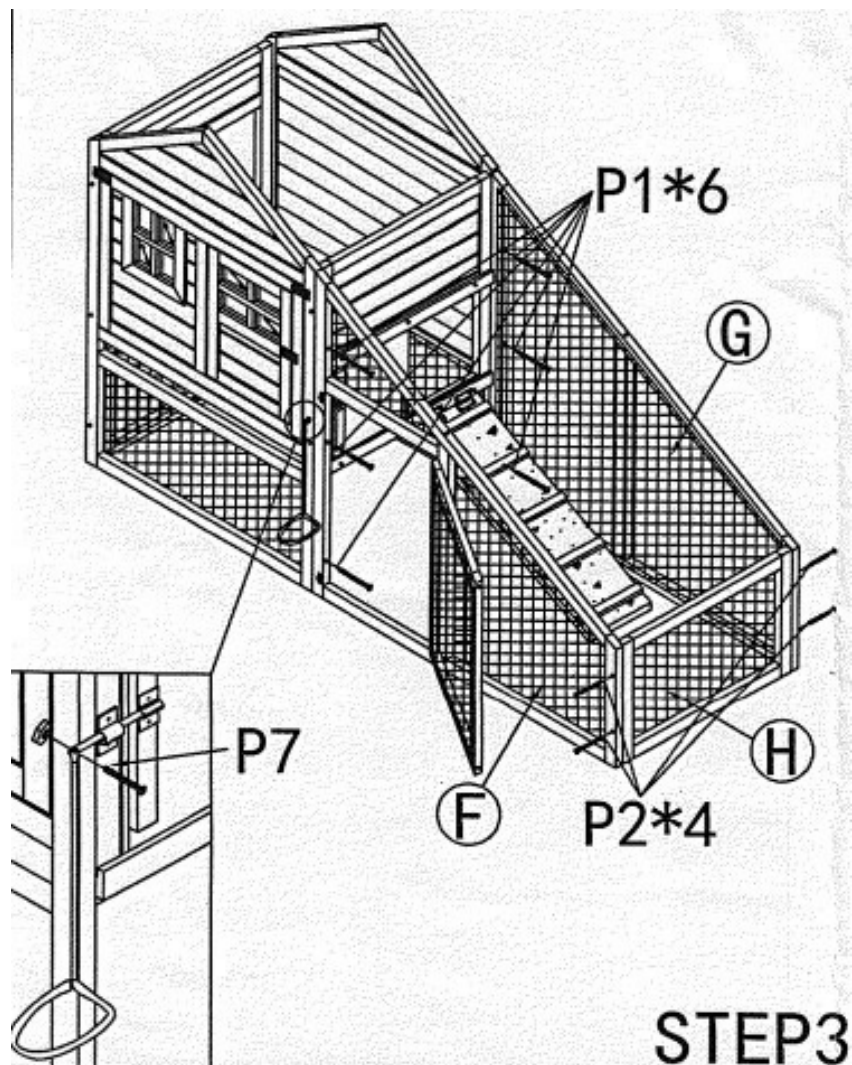

STEP 3

How to Assemble the Chalet Step 4

PARTS

Parts required for step 4

I, J, K1, K2, L, S

Screws

P6 x 4

Assemble The Nesting Box:

Align parts I, J, L to form the nest box, ensuring the divider slot on L is facing in.

Use P6 x 4 to attach to the sides of the house through the guide holes.

Next, place parts K1 and K2 in as shown, with the divider slot facing up.

Slide Part S into the designated slots to create the nest box divider.

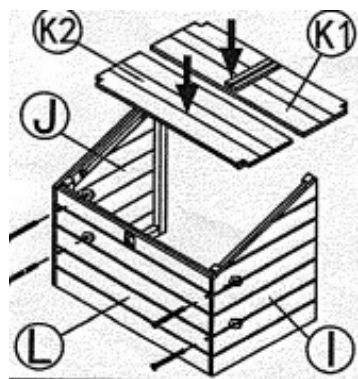

P6*4

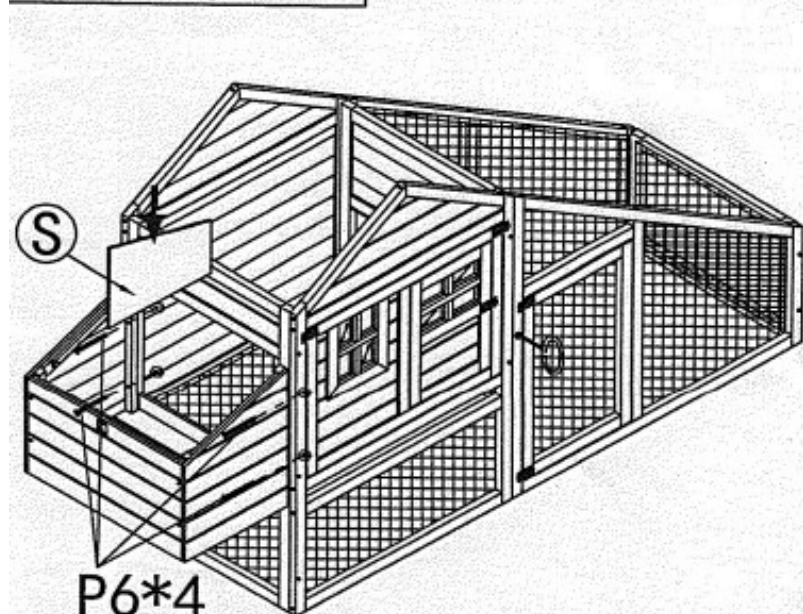

P6*4

STEP4

How to Assemble the Chalet Step 5

PARTS

Parts required for step 5

O

Screws

P5 x 6

Attach The Nest Box Lid: Align part O over the nest box, ensuring the latches line up and the lid is against the house.

Use screws P5 x 6 to attach the hinges of O to the house.

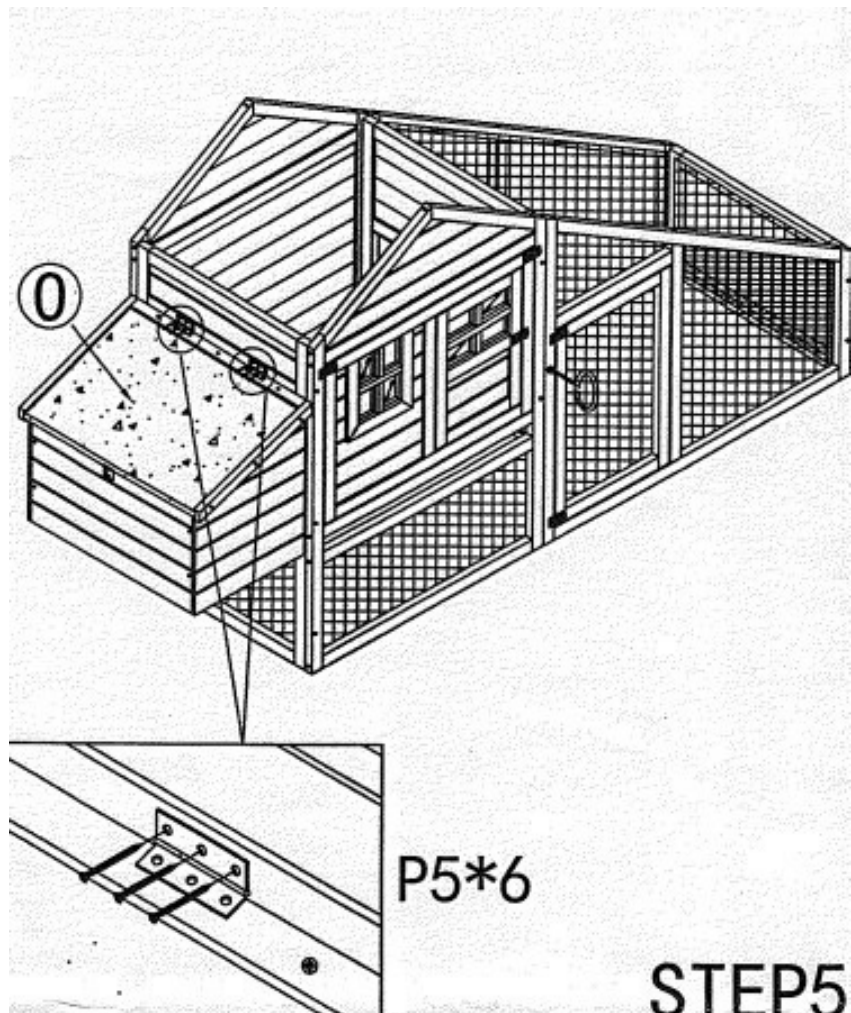

How to Assemble the Chalet Step 6

PARTS

Parts required for step 6

E, M, N x 2

Screws

P3 x 12

Insert The Pull Out Tray: Slide part E into the open slot of the house. Ensure the handle side is positioned at the front.

Attach The Roof Over The House: Align parts N x 2 over the house section. One of the panels will have an extension of the asphalt sheeting, ensuring this is positioned closest to the run side and overlaps the lower panel. Locate the pre-drilled holes in the roof panels and use screws P3 x 8 to attach.

Next, place roof panel M over the run area, ensuring the asphalt flap extension sits over the top of M. Locate the predrilled holes, then use screws P3 x 4 to attach.

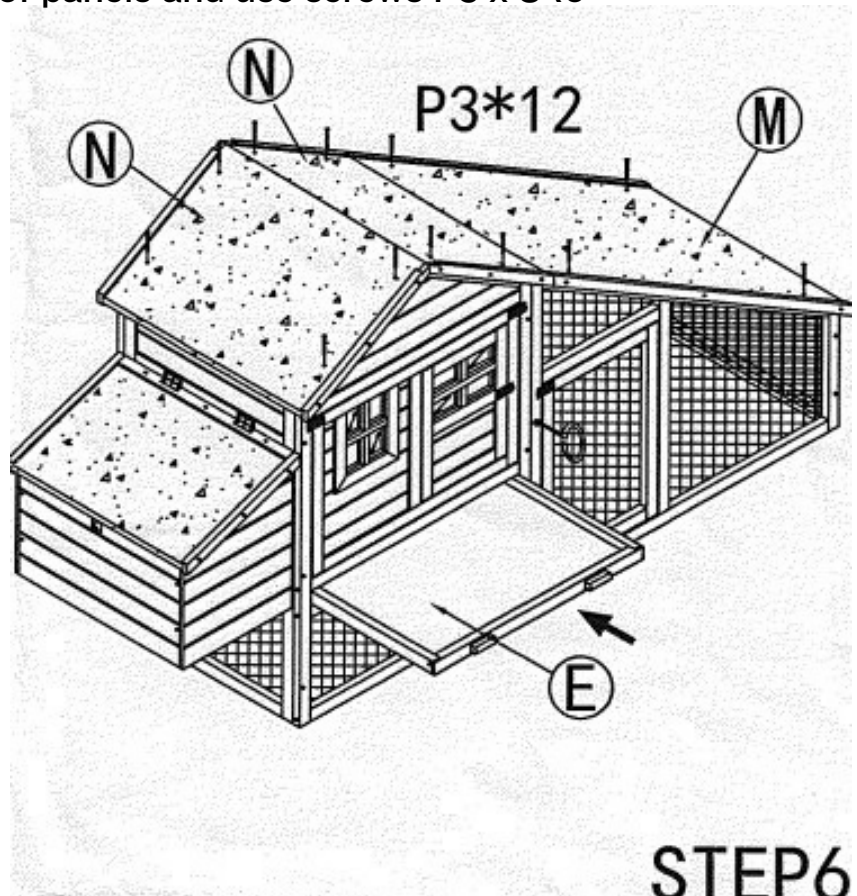

How to Assemble the Chalet Step 7

PARTS

Parts required for step 7

R

Screws

P4 x 4

Attach The Roof Cap:

Align part R over the roof join of the house as shown.

Use P4 x 8 to attach part R to the roof panels using the pre-drilled holes.

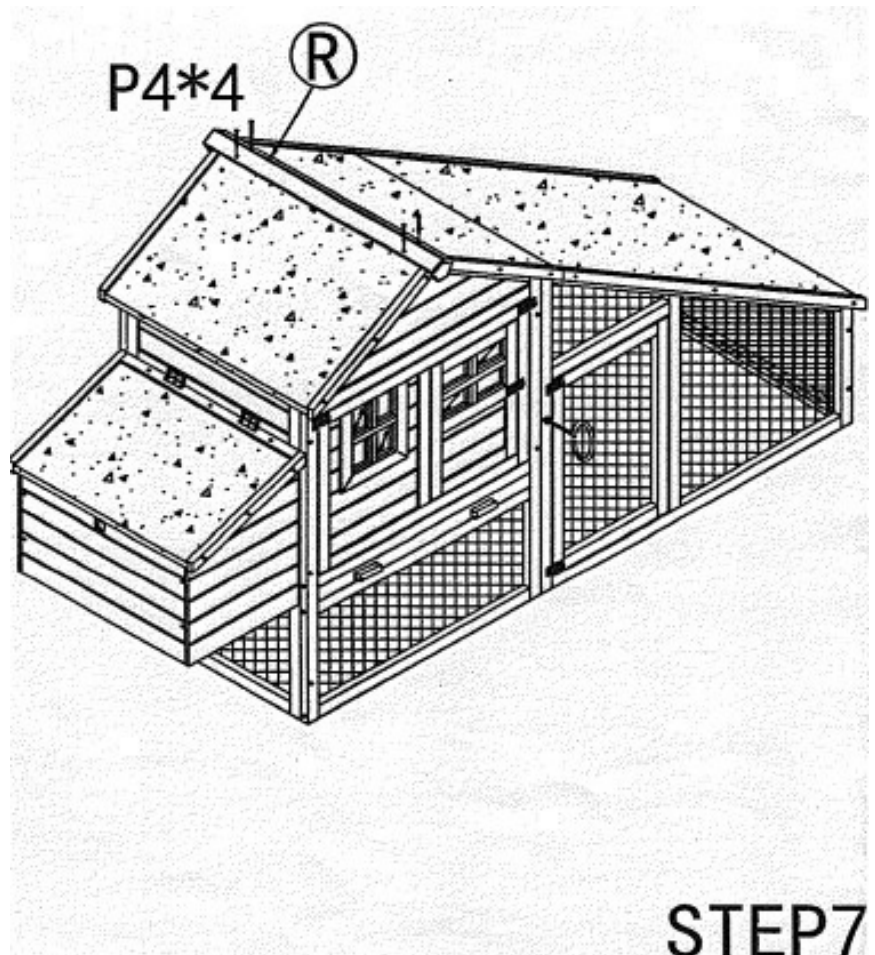

STEP 7



FAQ

Frequently asked questions

Contact Information

Phone: 02 4340 4200

Email: info@somerzby.com.au

Customer Service Office Hours

Monday – Thursday: 9:00am – 4:30pm

Friday: 9:00am – 4:00pm

Saturday & Sunday: Closed

Public holidays: Closed

www.somerzby.com.au

#somerzby

