

DELUXE MANSION

ASSEMBLY GUIDE



Welcome!

Congratulations on becoming an owner of a premium Somerzby product! We hope it brings you and your pet/s many years of enjoyment and contentment.

When your flat pack arrives, please check all items for any damage that might have occurred in transit.



02 4340 4200

info@somerby.com.au

What you will need









You'll need a battery-powered screwdriver or drill with a Phillips head bit, as well as a flat, level surface to ensure proper alignment of all doors during assembly.

Important Things To Note



- The instructions and screws can be found in carton #1.
- A strong smell may be present when opening. This is the natural timber scent and is not harmful to humans or animals. It will fade over time, especially when placed outdoors.
- When joining two panels, the 1st panel has a guide hole to show where the screw goes. The 2nd panel does not have a predrilled hole. The screw goes directly into the solid timber and forms a tighter join.
- You may notice a shiny or powdery residue on the panels; this is crystallised sap from the natural wood-drying process. It's completely safe for pets and people and can be wiped off or left as is.

Check list

P1	 3.5 × 60mm	6pcs+1 spare	P4	 3.5 × 25mm	25pcs+1 spare
P2	 3.5 × 45mm	22pcs+1 spare	P5	 3 × 14mm	14pcs+1 spare
P3	 3.5 × 35mm	21pcs+1 spare	P6	 1pc	

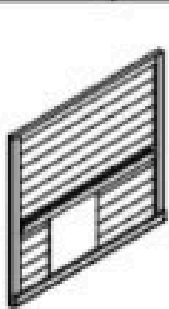

Ⓐ X1



Ⓑ X1

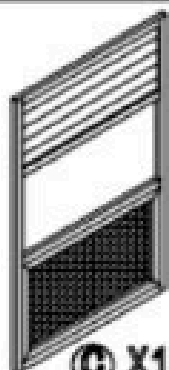

Ⓒ X1

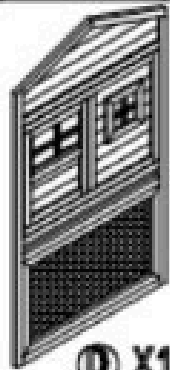

Ⓓ X1



Ⓔ X1

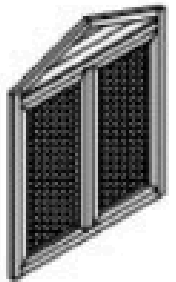

Ⓕ X1

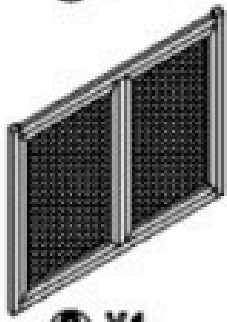

Ⓖ X1

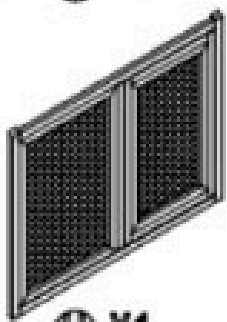

Ⓖ X1



Ⓙ X1



Ⓚ X2



Ⓛ X1

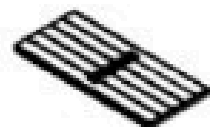

Ⓛ X1

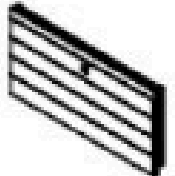

Ⓜ X1



Ⓝ X1

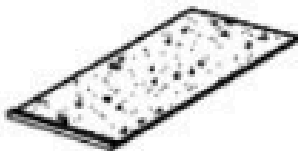

Ⓞ X1



Ⓟ X1

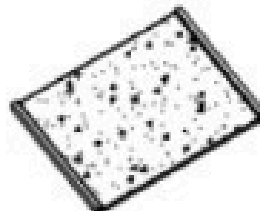

Ⓠ X2



Ⓡ X1



Ⓢ X1



Ⓣ X1



Ⓤ X1

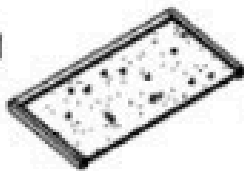

Ⓡ X1

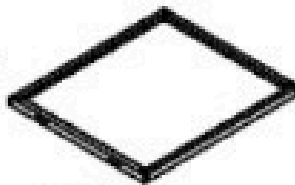

Ⓢ X1

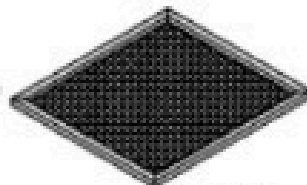

Ⓣ X1

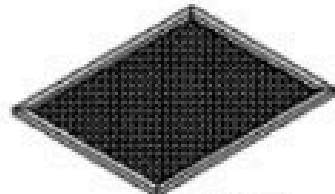

Ⓤ X1

How to Assemble the Deluxe Mansion Step 1

PARTS

Parts required for step 1:

A, B, C, D

Screws: P2 x 10

Assemble The Housing Area:

Attach Panel B to C: Locate the pre-drilled holes on panel B. Use screws P2 x 3 to attach, ensuring the stapled side of the wire is on the inside.

Attach Panel C to D: Locate the pre-drilled holes on panel D. Use screws P2 x 3 to attach, ensuring the stapled side of the wire is on the inside.

Attach Panel A to B and D: Use the guide dowels on panel A to slot into B and D ensuring the U shaped roosting pole holders on panel A face internally.

Use the pre-drilled holes on B and D, attach to panel A using screws P2 x 4.

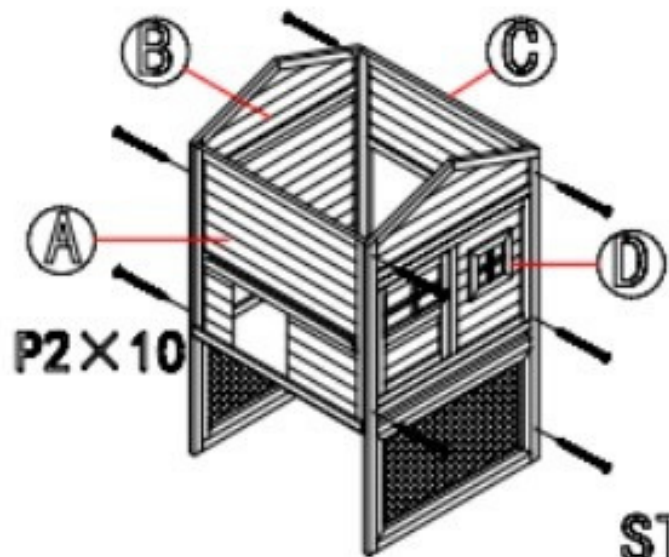

How to Assemble the Deluxe Mansion Step 2

PARTS

Parts required for step 2 :

E, X

Screws: P5 x 4, P2 x 4

Attach The Wire Floor Panel: Place panel X flat on the ground under the house section, with the wire against the ground and the thick frame on top.

Locate the predrilled holes and use screws P2 x 4 to attach.

Attach The Ramp To The House: Use screws P5 x 4 to attach the hinges of the ramp below the small entry door to the house.

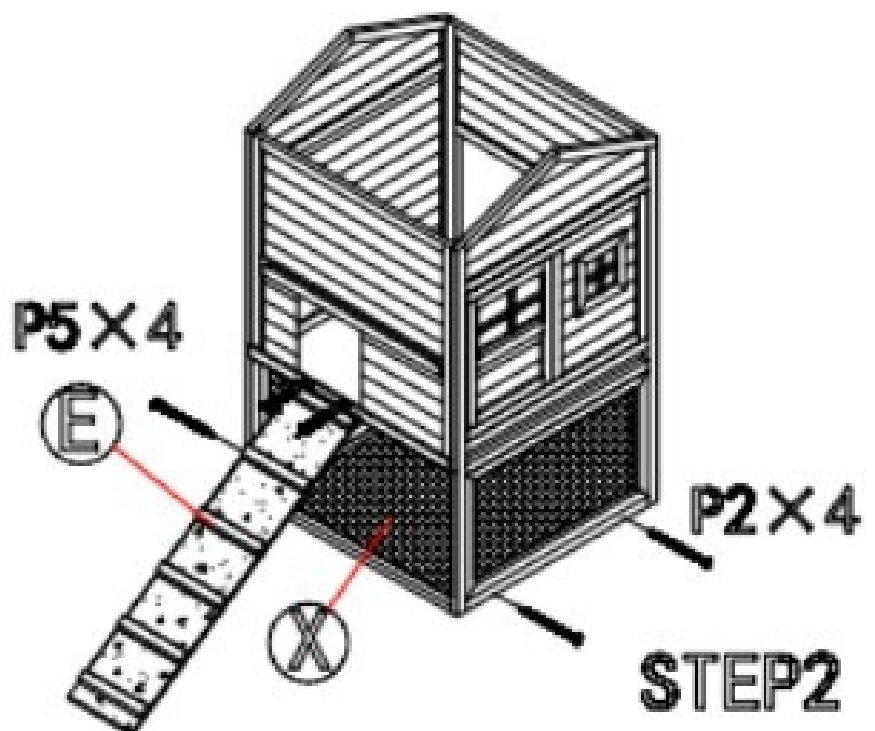

How to Assemble the Deluxe Mansion Step 3

PARTS

Parts required for step 3:

F, G, H, Y

Screws: P2 x 8

Assemble The Run Section:

Attach F to G: Locate the pre-drilled holes on panel G.

Align with the side of panel F, ensuring the wire side with staples is facing in.

Use screws P2 x 2 to attach.

Attach F to H: Locate the pre-drilled holes on panel H.

Align with the side of panel F ensuring the wire side with staples is facing in.

Use screws P2 x 2 to attach.

Attach The Wire Floor:

Place panel Y flat on the ground between the run panels, with the wire against the ground and the thick frame on top.

Locate the pre-drilled holes and use screws P2 x 4 to attach.

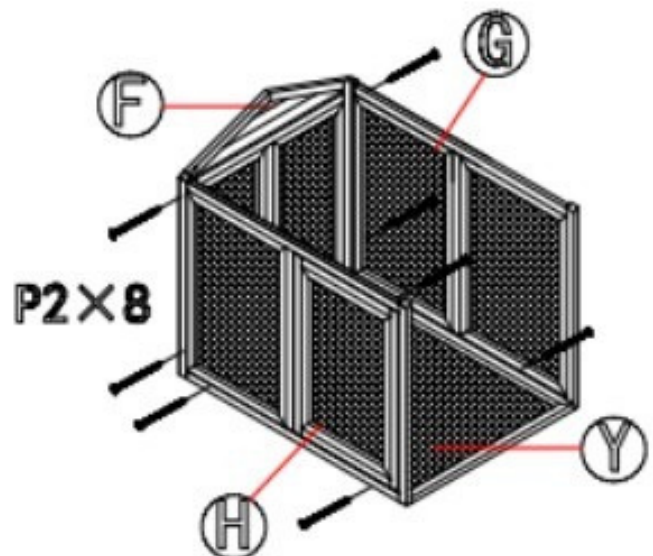

How to Assemble the Deluxe Mansion Step 4

PARTS

Parts required for step 4:

I, 2 x J, P6

Screws: P1 x 6, P3 x 2, P5 x 4

Attach The Roof Support: Using screws P3 x 2, attach roof support part I against the house above the door.

Position Roosting Poles: Place 2 x J into 'U' shaped holders inside the house.

** If not using to house chickens, part J can be left out**

Remove Flyscreen Panel on part H: Using a powered screwdriver, remove the inner flyscreen panel from Part H to expose the pre-drilled holes.

These holes are used to attach the run to the house.

"the fly screen panel needs to be removed from one side of the run so it can be screwed to the house part, then the fly screen screwed back in".

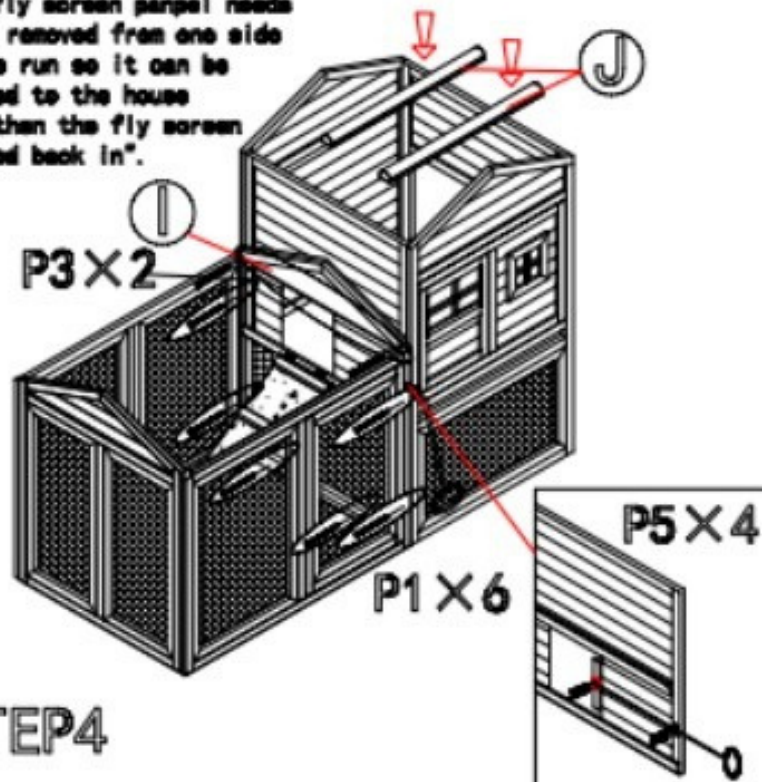

How to Assemble the Deluxe Mansion Step 5

PARTS

Parts required for step 5:

K, L, M, N

Screws: P4 x 17, P3 x 3

Assemble The Nesting Box: Place part L on a flat surface, align panels K, M and N to form the sides.

Ensure the pre-drilled holes on base panel L are located at the open side and the divider slots of L and M are facing in.

Using the pre-drilled holes, screw panels K, L, M and N using screws P4 x 11.

Attach The Nest Box To The House: Align the nest box into the opening of the side of the house, ensuring it is flush with the edges.

Using the pre-drilled holes on the nest box, use screws P3 x 3 to attach the base of the box to the house.

Use screws P4 x 6 to attach the sides of the nest box to house.

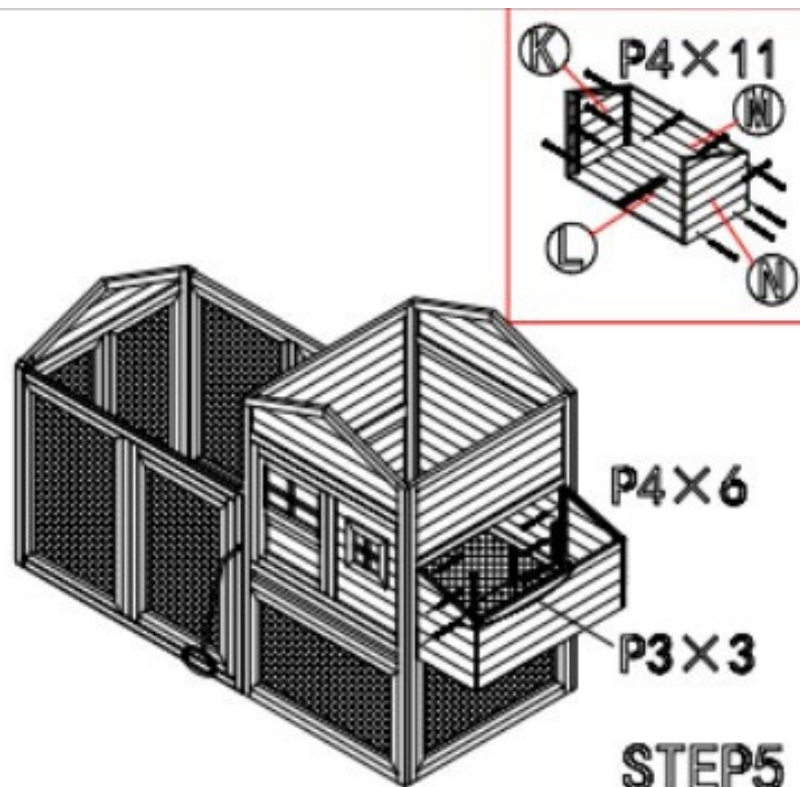

STEP 5

How to Assemble the Deluxe Mansion Step 6

PARTS

Parts required for step 6:

O, P, Q x 2

Screws: P3 x 16

Attach The Roof On The Run: Align parts O and P over the run section, ensuring the capped wooden edge is furthest from the house.

Locate the pre-drilled holes in the roof panels and use screws P3 x 8 to attach.

Attach The Roof Over The House: Align parts Q x 2 over the house section.

Locate the pre-drilled holes in the roof panels and use screws P3 x 8 to attach.

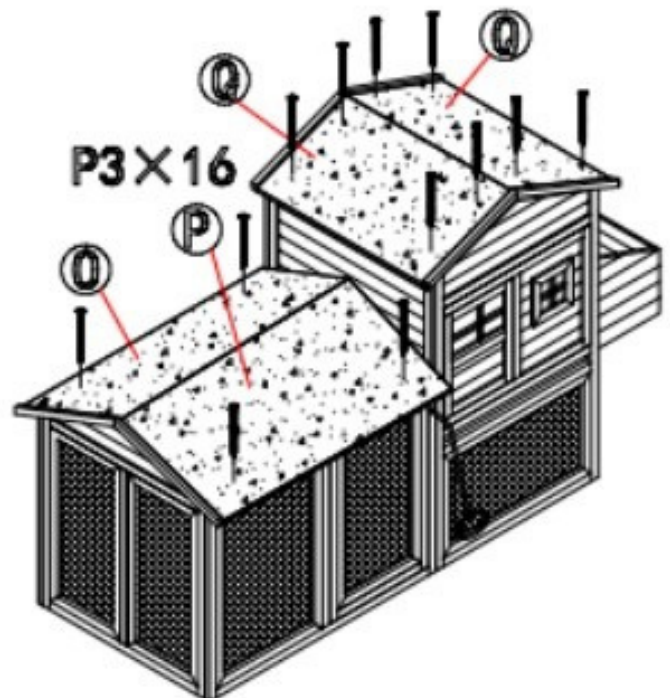

How to Assemble the Deluxe Mansion Step 7

PARTS

Parts required for step 7:

R, S, T, U

Screws: P4 x 8

Attach The Roof Caps: Place part R over the roof joins of O and P, ensuring the capped end is furthest from the house and the uncapped end sits against the house.

Place part S over the join where parts Q meet, ensuring it sits neatly along the seam.

Use P4 x 8 to attach to parts R and S to the roof panels using the pre-drilled holes.

Add The Nest Box Components:

Place part U along the inside edge of 1 nest box, with the roosting pole holder facing towards the house.

Slide part T into the nest box guides as shown. ****This can be left out if not using for chickens.****

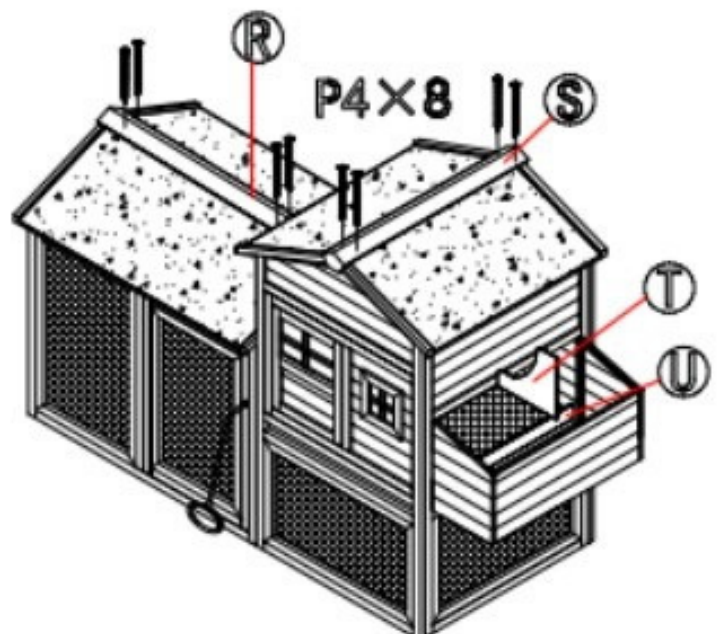

How to Assemble the Deluxe Mansion: Finish

PARTS

Parts required for Finish:

V, W

Screws: P5 x 6

Attach The Nest Box Lid: Align part V over the nest box, ensuring the latches line up and the lid is against the house.

Use screws P5 x 6 attach the hinges of V to the house.

Insert The Pull Out Tray: Slide part W into the open slot of the house.

Ensure the handle side is positioned at the front.

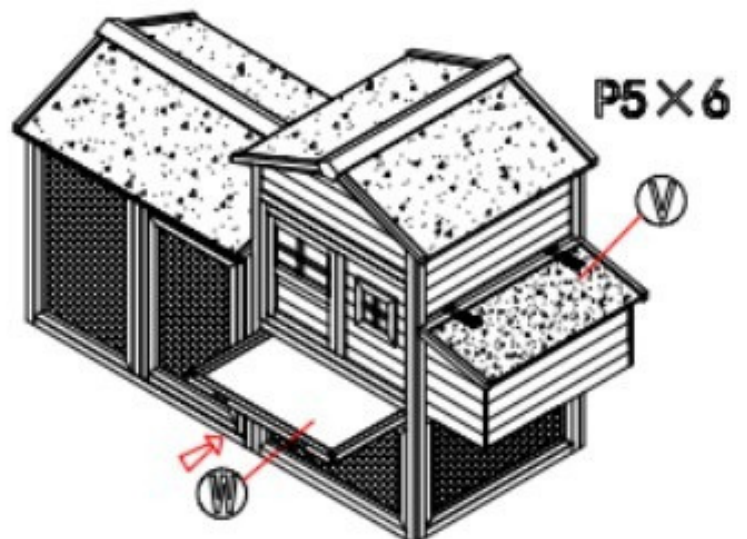

FINISH



FAQ

Frequently asked questions

Contact Information

Phone: 02 4340 4200

Email: info@somerzby.com.au

Customer Service Office Hours

Monday – Thursday: 9:00am – 4:30pm

Friday: 9:00am – 4:00pm

Saturday & Sunday: Closed

Public holidays: Closed

www.somerzby.com.au

#somerzby

