

# ESTATE ASSEMBLY GUIDE



## Welcome!

Congratulations on becoming an owner of a premium Somerzby product! We hope it brings you and your pet/s many years of enjoyment and contentment.

When your flat pack arrives, please check all items for any damage that might have occurred in transit.



02 4340 4200

[info@somerby.com.au](mailto:info@somerby.com.au)

## What you will need



















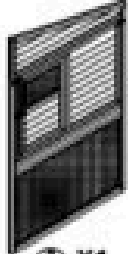
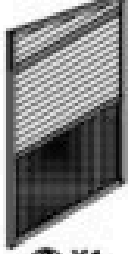
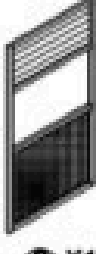
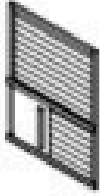

You'll need a battery-powered screwdriver or drill with a Phillips head bit, as well as a flat, level surface to ensure proper alignment of all doors during assembly.

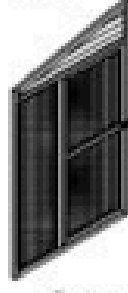
## Important Things To Note

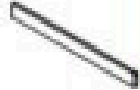
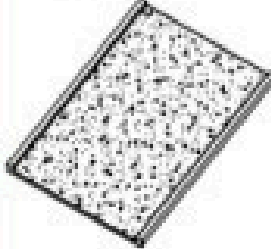
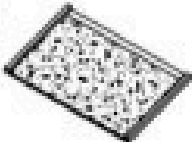
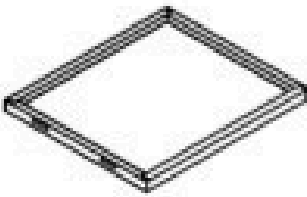

- The instructions and screws can be found in carton #1.
- A strong smell may be present when opening. This is the natural timber scent and is not harmful to humans or animals. It will fade over time, especially when placed outdoors.
- When joining two panels, the 1st panel has a guide hole to show where the screw goes. The 2nd panel does not have a predrilled hole. The screw goes directly into the solid timber and forms a tighter join.
- You may notice a shiny or powdery residue on the panels; this is crystallised sap from the natural wood-drying process. It's completely safe for pets and people and can be wiped off or left as is.

## Check list

 <b>P1</b> <b>3.5 X 60mm</b> <b>8pcs+1 spare</b>	 <b>P2</b> <b>3.5 X 45mm</b> <b>22pcs+1 spare</b>	 <b>P3</b> <b>3.5 X 35mm</b> <b>11pcs+1 spare</b>		
 <b>P4</b> <b>3.5 X 25mm</b> <b>29pcs+1 spare</b>	 <b>P5</b> <b>3 X 14mm</b> <b>14pcs+1 spare</b>	 <b>P6</b> <b>1pc</b>		
 <b>A</b> X1	 <b>B</b> X1	 <b>C</b> X1	 <b>D</b> X1	 <b>E</b> X1
 <b>F</b> X1	 <b>G</b> X1	 <b>H</b> X1	 <b>I</b> X2	 <b>J</b> X1
 <b>K</b> X1	 <b>L</b> X1	 <b>M</b> X1	 <b>N</b> X1	 <b>O</b> X1
 <b>P</b> X2	 <b>Q</b> X1	 <b>R</b> X1	 <b>S</b> X1	 <b>T</b> X2

## How to Assemble the Estate Step I

### PARTS

#### Parts required for step 1

A, B, C, D, E

#### Screws:

P2 x 14, P5 x 4

#### Assemble The Housing Area:

**Attach Panel A to C:** Align panels A and C, ensuring the stapled side of the wire is on the inside. Locate the pre-drilled holes on panel A. Use screws P2 x 4 to attach,

**Attach Panel C to B:** Align panels B and C, ensuring the stapled side of the wire is on the inside. Locate the pre-drilled holes on panel B. Use screws P2 x 4 to attach.

**Attach Panel D to A and B:** Use the guide dowels on panel D to slot into B and A ensuring the U shaped roosting pole holders on panel D face internally.

Use the pre-drilled holes on A and B attach to panel D using screws P2 x 6.

#### Attach The Ramp To The House:

Use screws P5 x 4 to attach the hinges the ramp below the small entry door to the house.

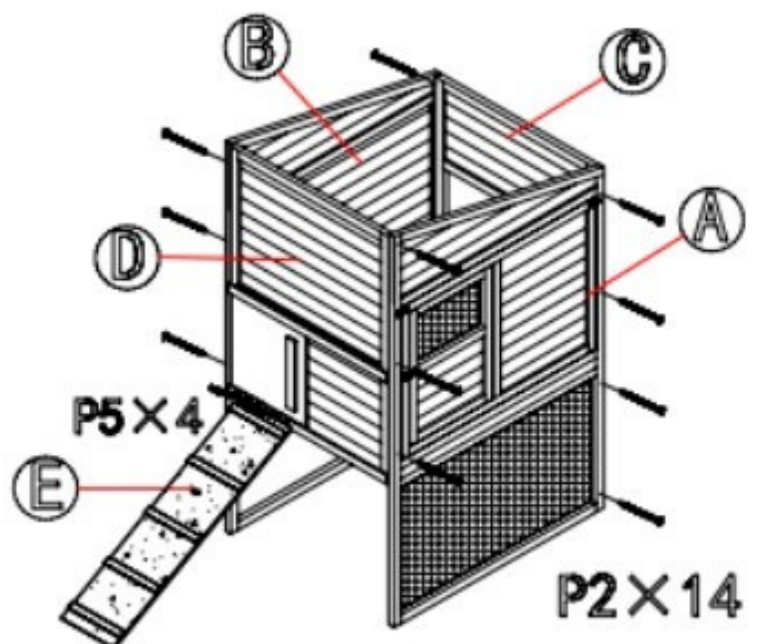

## How to Assemble the Estate Step 2

### PARTS

#### Parts required for step 2

F, G, H

#### Screws:

P1 x 8, P2 x 8

#### Assemble The Run Area:

**Attach F to B:** Locate the pre-drilled holes on the inner edge of panel F.

Align with the side of panel B, ensuring the wire side with staples is facing in.

Use screws P1 x 4 to attach.

**Attach H to A:** Locate the pre-drilled holes on panel H.

Align with the side of panel A ensuring the wire side with staples is facing in.

Use screws P1 x 4 to attach.

#### Attach G to F and H:

Align panel G between panels F and I ensuring the wire side with staples is facing in.

Locate the pre-drilled holes on H and F, then use screws P2 x 8 to attach.

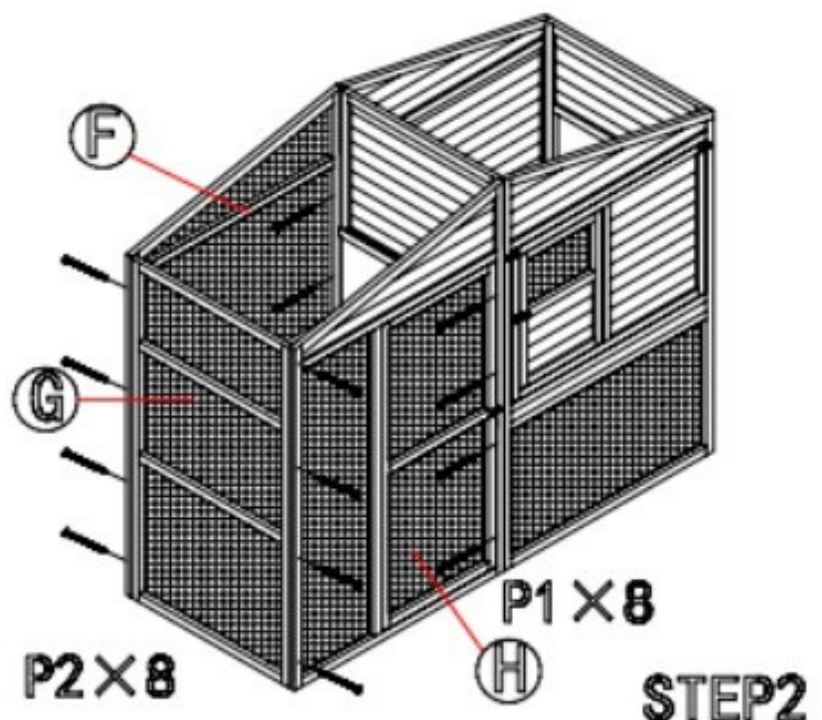

## How to Assemble the Estate Step 3

### PARTS

#### Parts required for step 3

1 x 2, P6

#### Screws

P5 x 4

**Position Roosting Poles:** Place 2 x J into 'U' shaped holders inside the house. Note: These can be left out if not using for chickens, or left in as a safe chew toy for rabbits or guinea pigs.

**Attach The Handle:** Use screws P5 x 2 attach the small metal rod to the front edge of the sliding door. Make sure it lines up with the hole in the front panel of the run.

Use screws P5 x 2 to attach the rod guide bracket to the house, in line with the rod.

Slide the small rod through the bracket and into the round hole on the run panel.

Join the two handle pieces together from the outside using the P6 nut and bolt- a shifting spanner may be required.

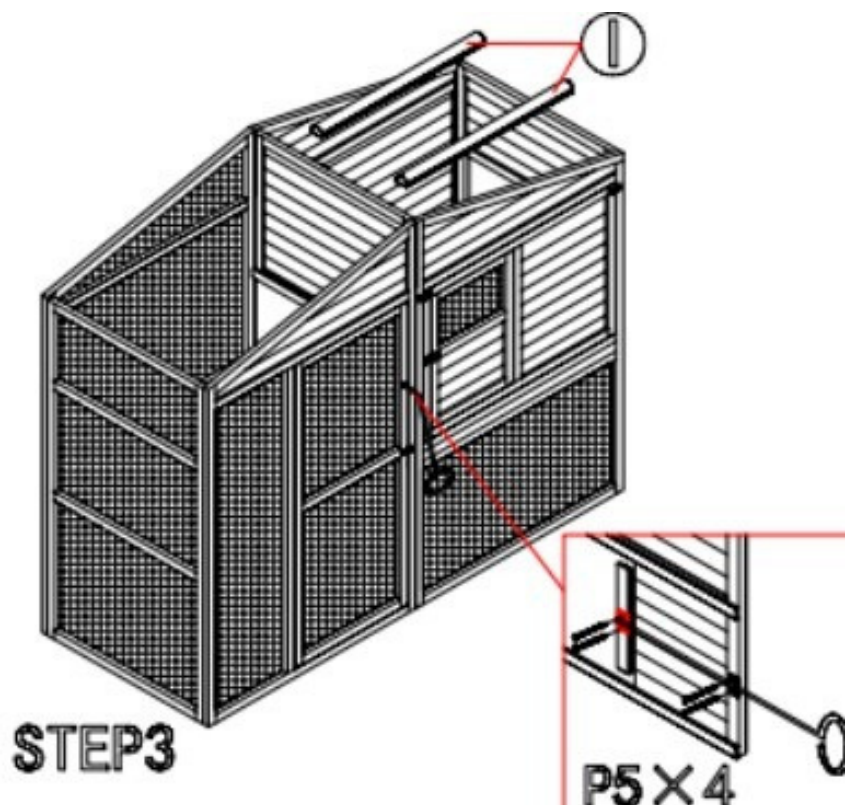

## How to Assemble the Estate Step 4

### PARTS

#### Parts required for step 4

J, K, L, M

#### Screws

P3 x 3, P4 x 21

**Assemble The Nesting Box:** Place part L on a flat surface, align panels K, M and J to form the sides.

Ensure the pre-drilled holes on base panel L are located at the open side and the divider slots of L and J are facing in towards each other.

Using the pre-drilled holes, screw panels K, L, M and J together using screws P4 x 15.

**Attach The Nest Box To The House:** Align the nest box into the opening of the side of the house, ensuring it is flush with the edges.

Using the pre-drilled holes on the nest box, use screws P3 x 3 to attach the base of the box to the house.

Use screws P4 x 6 to attach the sides of the nest box to the house.

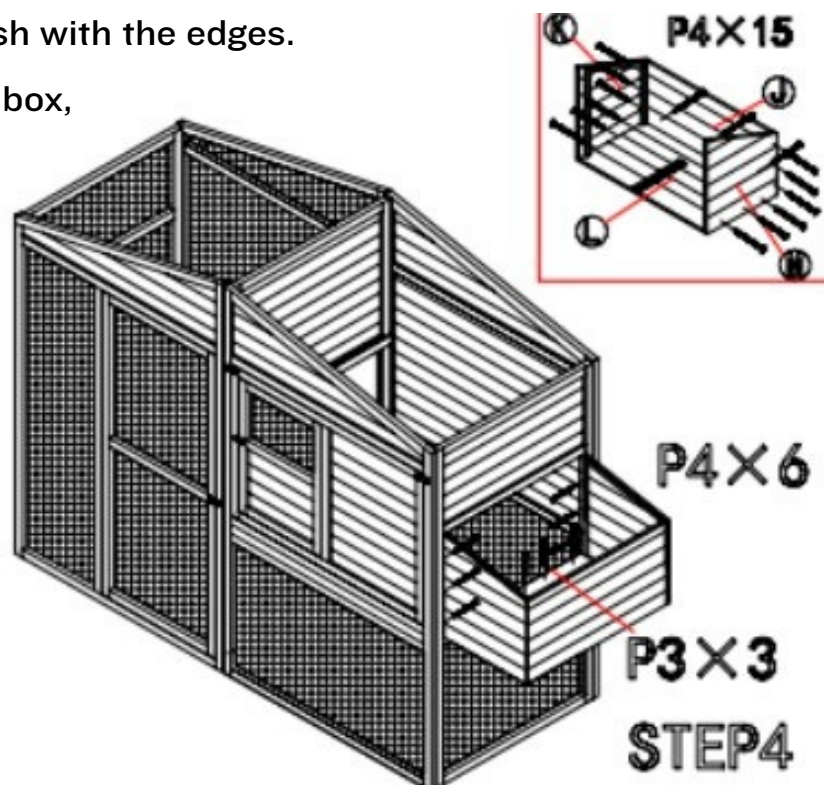

## How to Assemble the Estate Step 5

### PARTS

#### Parts required for step 5

P x 2, N, O

#### Screws

P3 x 8

**Attach The Roof Over The House:** Align parts P x 2 over the enclosure. Locate the pre-drilled holes in the roof panels and use screws P3 x 8 to attach.

**Add The Nest Box Components:** Place part O along the inside edge of the nest box, with the roosting pole holders facing towards the house.

Slide part N into the nest box guides as shown.

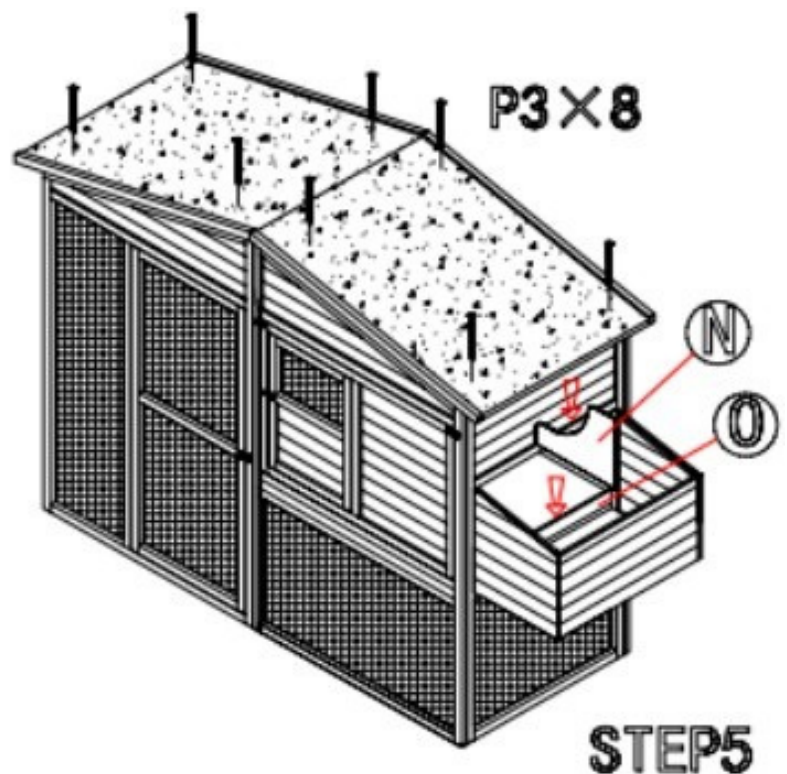

## How to Assemble the Estate Step FINISH

### PARTS

#### Parts required for step FINISH

Q, R, S, T

#### Screws

P5x 6, P4 x 8

**Attach The Roof Caps:** Place part S over the roof joins.

Use P4 x 4 to attach using the pre-drilled holes.

Next, attach T x 2 over the front and back joins of the roof panels as shown using P4 x 4.

**Attach The Nest Box Lid:** Align part Q over the nest box, ensuring the latches line up and the lid is against the house.

Use screws P5 x 6 attach the hinges of Q to the house.

**Insert The Pull Out Tray:** Slide part R

into the open slot of the house.

Ensure the handle side is positioned at the front.

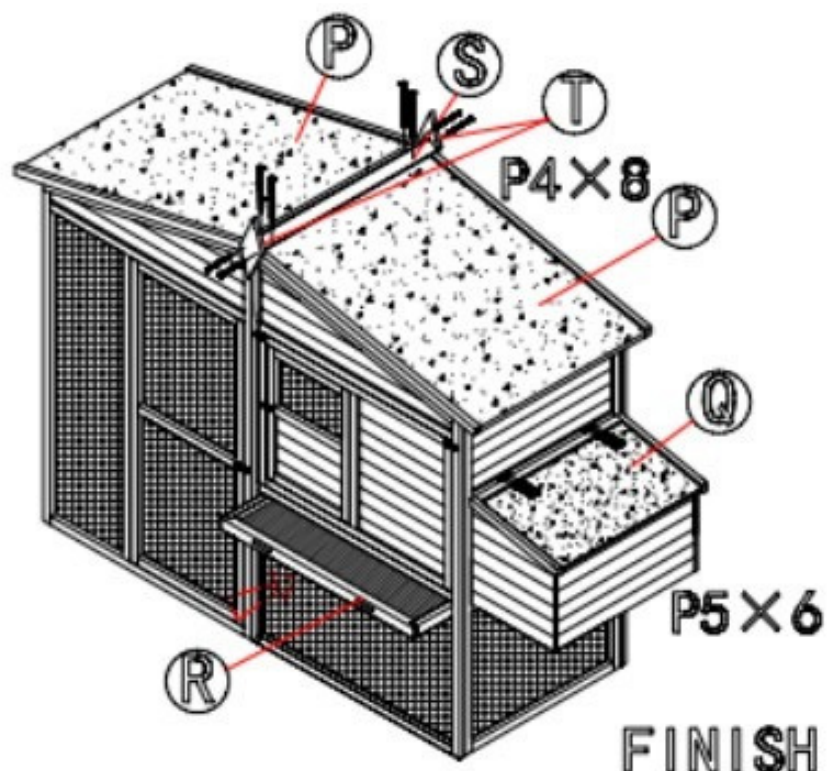

# Product Dimensions

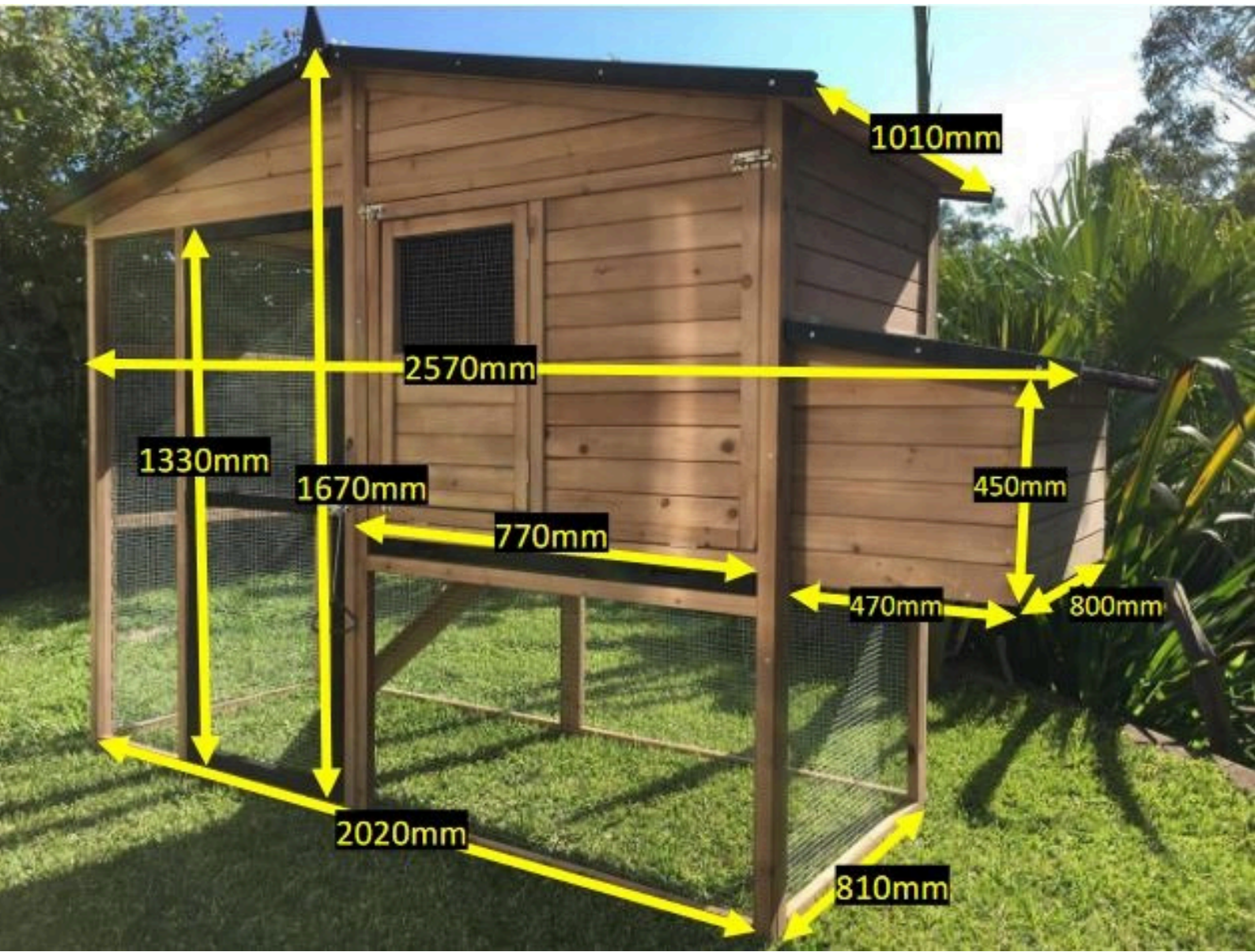



## FAQ

Frequently asked questions

### Contact Information

Phone: 02 4340 4200

Email: [info@somerzby.com.au](mailto:info@somerzby.com.au)

### Customer Service Office Hours

Monday – Thursday: 9:00am – 4:30pm

Friday: 9:00am – 4:00pm

Saturday & Sunday: Closed

Public holidays: Closed

[www.somerzby.com.au](http://www.somerzby.com.au)

**#somerzby**

