

COOPER

ASSEMBLY GUIDE



Welcome!

Congratulations on becoming an owner of a premium Coops and Cages product! We hope it brings you and your pets many years of enjoyment and contentment.

When your flat pack arrives, please check all items for any damage that might have occurred in transit.



02 4340 4200

info@coopsandcages.com.au

What you will need



You'll need a flat, level surface to ensure proper alignment during assembly. An Allen key is provided with the screws.

Important Things To Note



- The instructions and screws can be found together in clear packaging.
- There is only ONE type of screw for the whole build.
- Be cautious of sharp points & edges

Check list

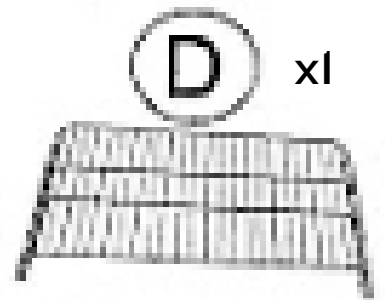
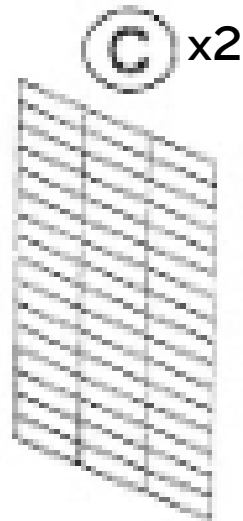
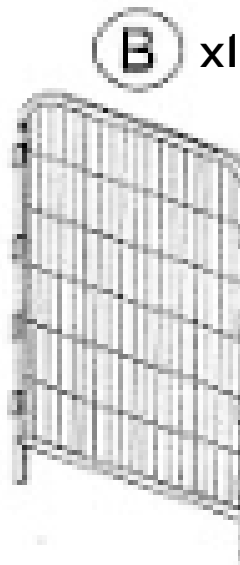
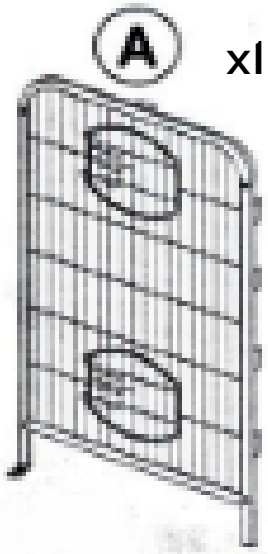

roof

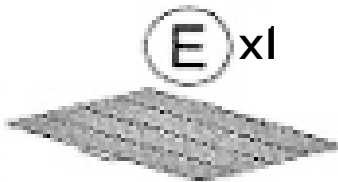

wire tray

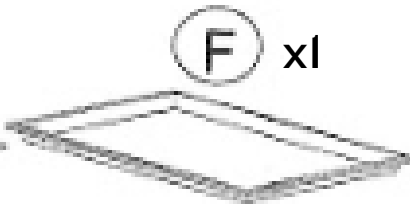

tray

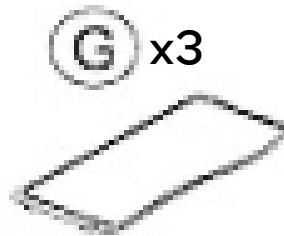

platform



ramp

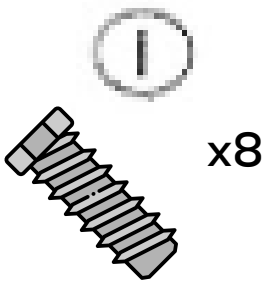

screws

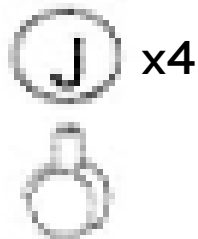

wheels



water bottle



side tube bar

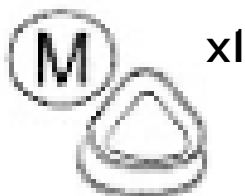

food bowl

How to Assemble the Cooper Step 1

PARTS

Parts required for step 1

A, B, L x2

Screws

I x 4 + Allen Key

Attach Part L to A:

Right side: With the doors on A facing you, align L to look like a '3' is facing inwards. Place L x I behind A, in line with the hole on the leg. The top of L should have a hole in the middle. When both L & A are aligned, use I x I to screw together

Left side: Align L to look like a 'E' is facing inwards. Place L x I behind A, in line with the hole on the leg. The top of L should have a hole in the middle. When both L & A are aligned, use I x I to screw together.

NOTE: B has metal brackets on the inside that need to be facing towards L/inside of the cage.

Attach Part L to B:

Align L to the hole on B's legs and use I x 2 to secure together.

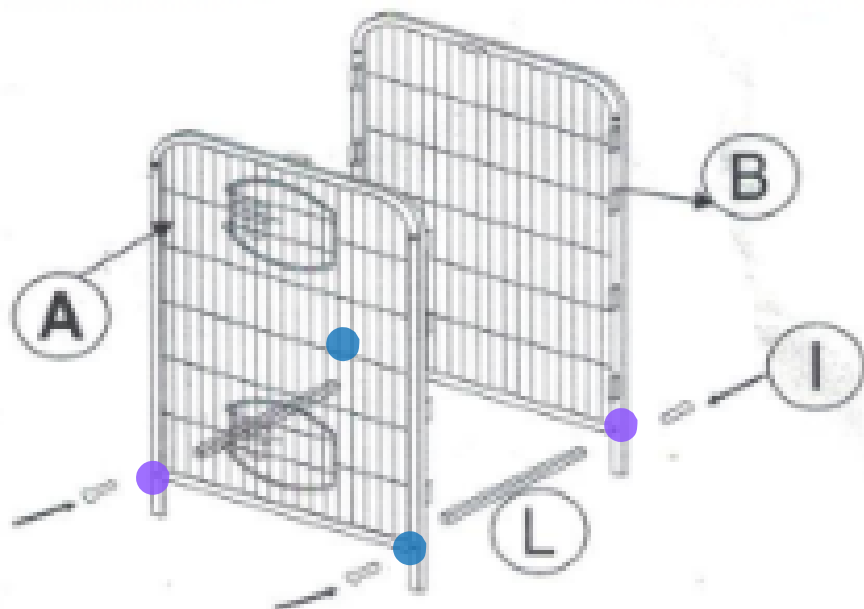

How to Assemble the Cooper Step 2

PARTS

Parts required for step 2

C x2, D

Screws

I x 4, Allen Key

Assemble the Side & Roof:

The Sides:

Parts A & B each have four metal brackets that you need to slide C between from the top on each side. The middle wire spike on C will fit into the hole on L, and the other end into the roof panel next. **Note: It doesn't matter which short end of C you have at the bottom or top. They're the same.**

The Roof:

The Metal edges on D each have a hole in the middle on the underside. Align the metal sides so that the middle spike on C fits into the hole. The wire edges of D need to fit into the **brackets on A & B**. Slightly pull A & B away from D and maneuver the wire edge to sit in the bracket.

Put I x 2 through the holes on A into D to secure the roof to A. Repeat for the B with I x 2.

Use Allen key to tighten all screws.

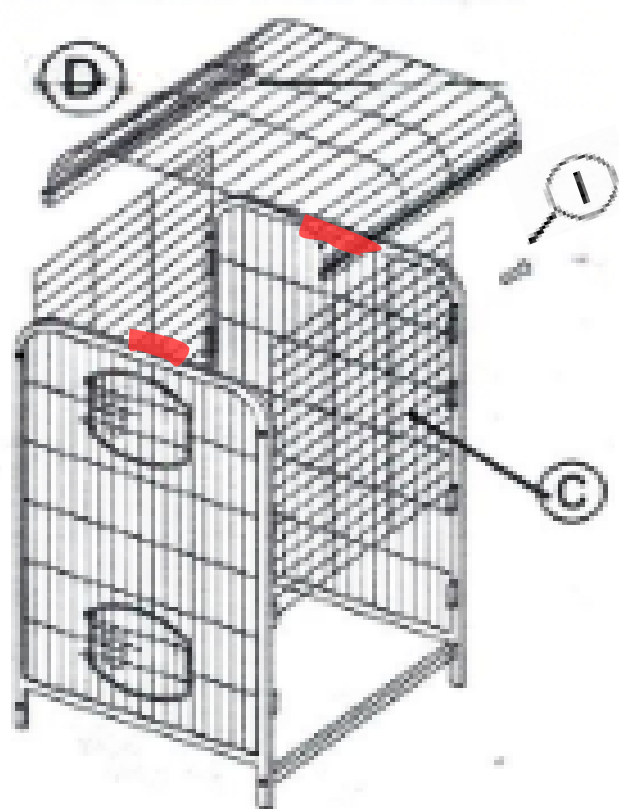

How to Assemble the Cooper Step 3

PARTS

Parts required for step 3

E, F, J x4

Attaching the Wheels to the Base:

Attaching Part J:

Turn the assembled cage to the side to access the legs of A and B. The long metal part of J is to be pushed into the hole in the 'legs' of A and B. The top of the metal cap covering the wheels is to be flush with the 'leg' of A and B. Attach all four J parts. Flip right way up.

Assemble the Bottom of the Cage:

Slide E (wire tray) into the top section of part L's rails. Move the hanging tab out of the way when inserting.

Slide F (plastic tray) directly underneath E in the bottom section of the rails.

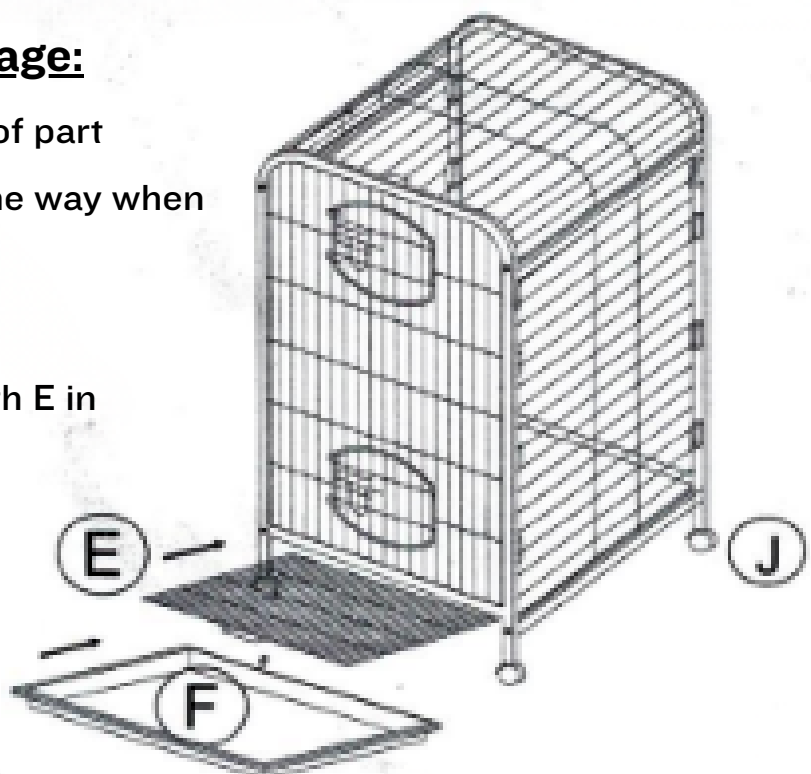
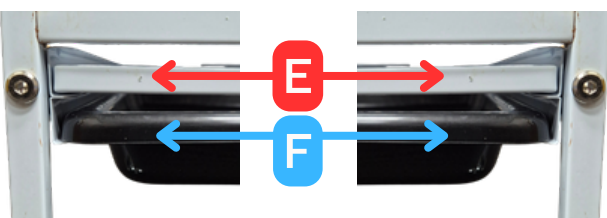

How to Assemble the Cooper Step 4

PARTS

Parts required for step 4

G x3, H x3, K, M



Assemble the Platforms:

Left Side

Open all the doors on **A**. G has two hooks on each short end. On the left side, you want G xl long straight side to be against C. The hooks are to be just above the horizontal wire in line with the middle of the **TOP** door. Lightly push the four hooks to clip onto the horizontal wire. Repeat for the bottom door.

NOTE: NOT TOO MUCH PRESSURE - It can snap!

Right Side

Place the long straight side of G xl against C on the right. Hooks are just above the horizontal wire between the **two** doors.

Lightly push the four hooks to clip onto the horizontal wire.

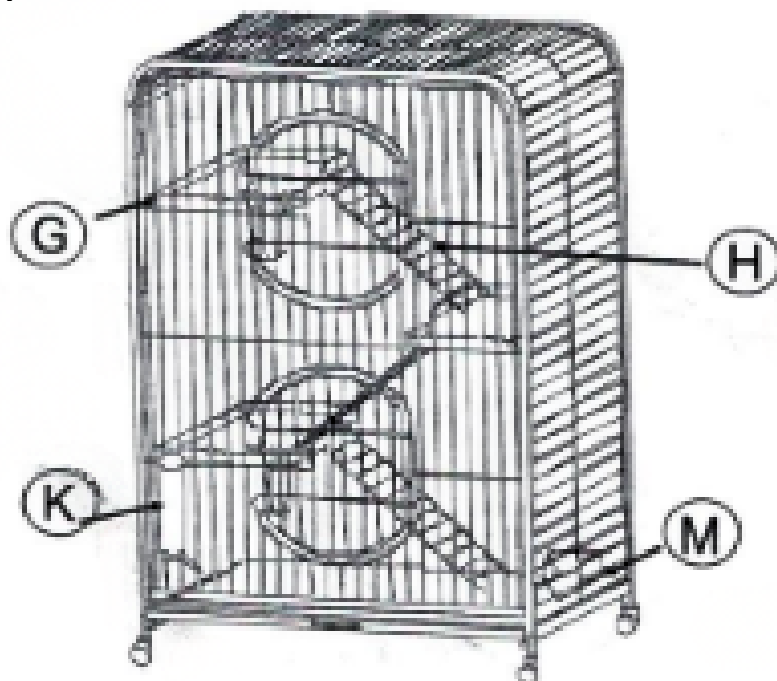

How to Assemble the Cooper Step 4 - Continued

PARTS

Parts required for step 4

G x5, H x5, K, M

Assemble the Ramps:

There are two hooks under the front of the G (platforms). The top of H has two holes. Hook H onto G. The end of the ramp should rest on the G platform on the opposite side.



Repeat for all G platforms.

Food and Water Containers:

Secure the clip part of K to the inside of the cage and hook the bottle onto the clip from the outside. Place K wherever your pet/s can access.

Place M wherever you would like.

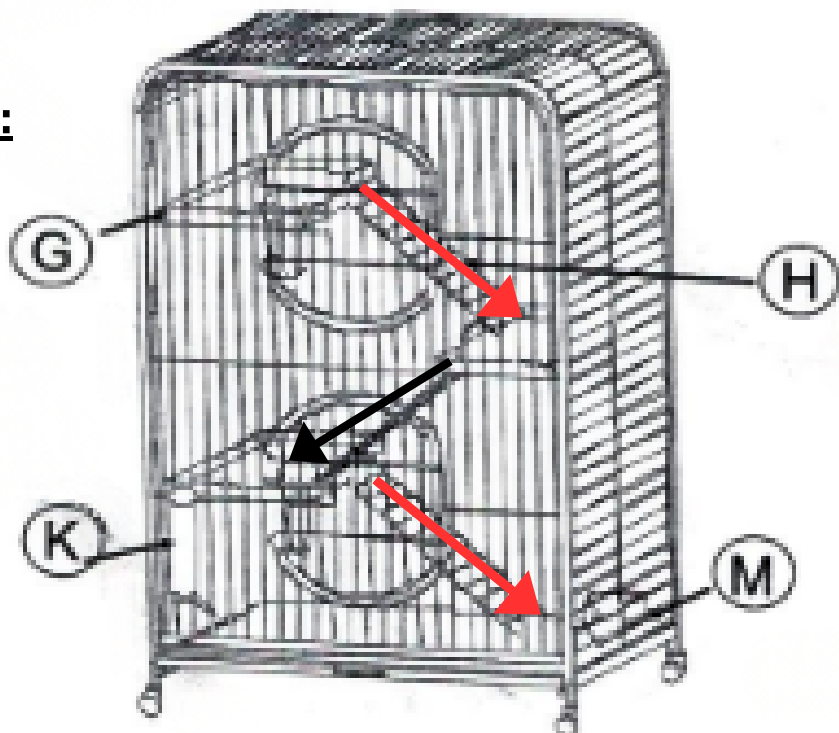

FINISH





FAQ

Frequently asked questions

Contact Information

Phone: 02 4340 4200

Email: info@somerzby.com.au

Customer Service Office Hours

Monday – Thursday: 9:00am – 4:30pm

Friday: 9:00am – 4:00pm

Saturday & Sunday: Closed

Public holidays: Closed

www.somerzby.com.au

#somerzby

